

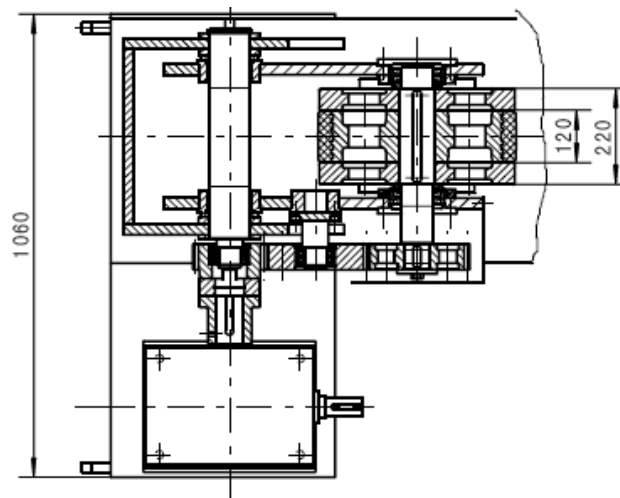

Unit 1, Vauxhall Street,
Dudley, DY1 1TA
TEL : 01384 232121 FAX : 01384 232333
www.mgwelding.co.uk Email : sales@mgwelding.co.uk

**TECHNICAL SPECIFICATION
SELF ALIGNING ROTATORS**

**SAR - 60
60 TONNE CAPACITY**

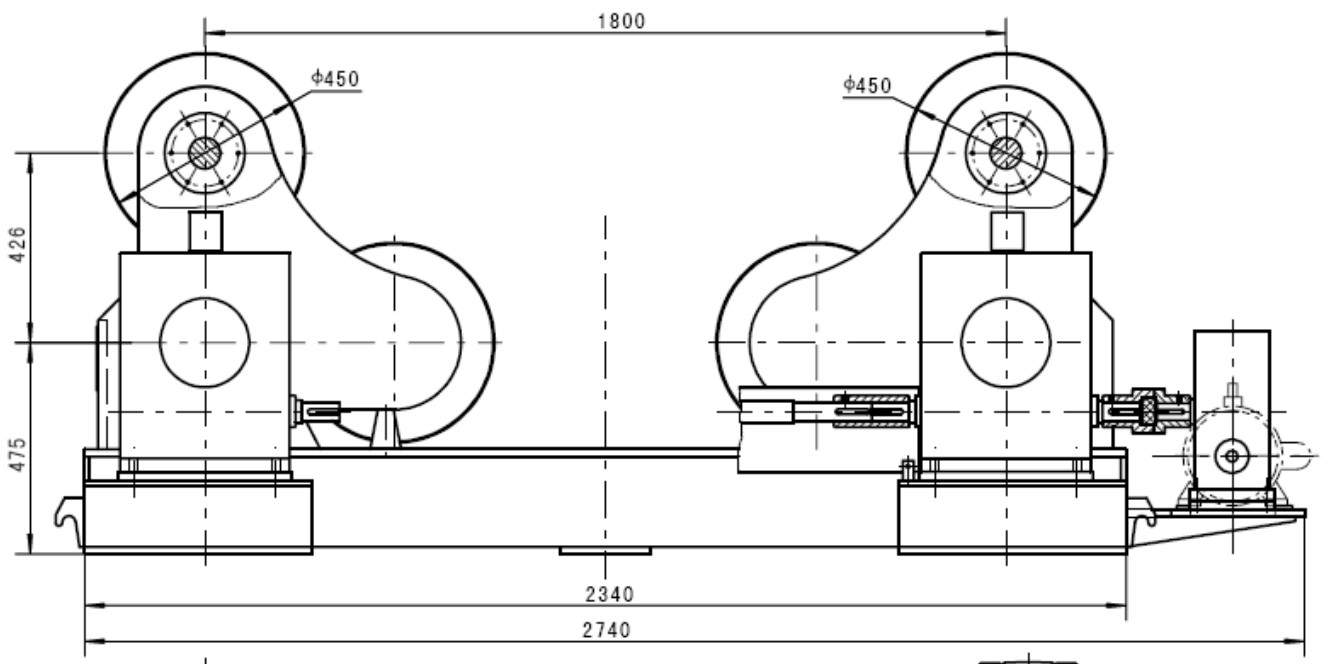

Idler

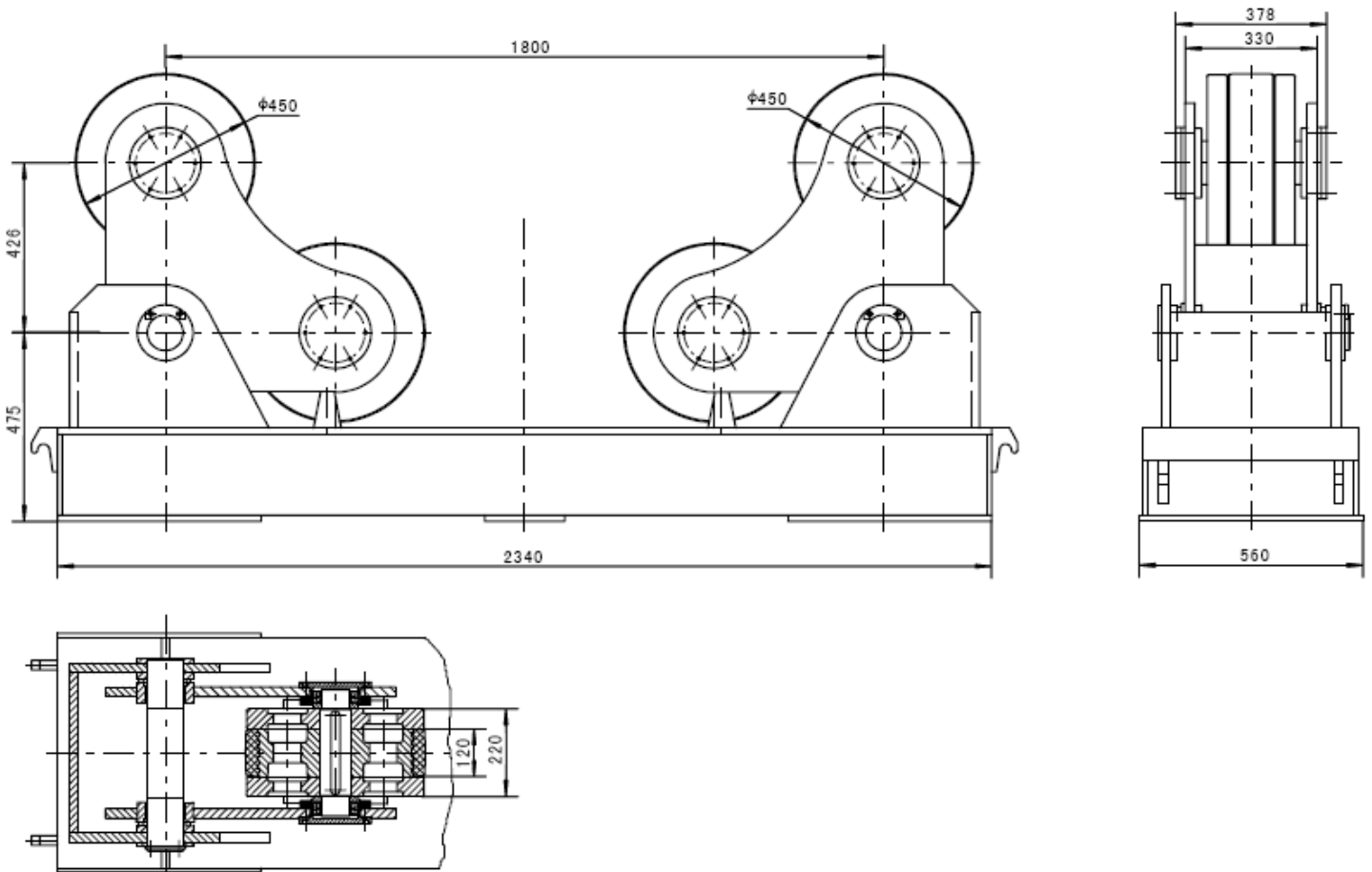

Model	Type	Load Capacity (tons)	Rotation Capacity (tons)	Rotation Speed (mm/min)	Power (KW)	Vessel Diameter (mm)	Wheel (mm)		Weight (tons)*
							Diam	Width	
SAR-60	Power	30	60	100-1000	4.00	750 - 6000	450	220	4.50
	Idler	30	N/A	N/A					